

- Brunalokanir
- Brunaslanga
- Gat í göf
- Gat í lofti
- Niðurfallsrör
- Gólfniðurfall
- Loftræsting
- Handslökkvitæki
- Reykskyrjar
- Reyklosun
- Lagnagrind vatnsúðarakerfi
- Stjórntaflla brunv. kerfis
- Tvíburatengi
- ÚT merking
- Björgunnarop

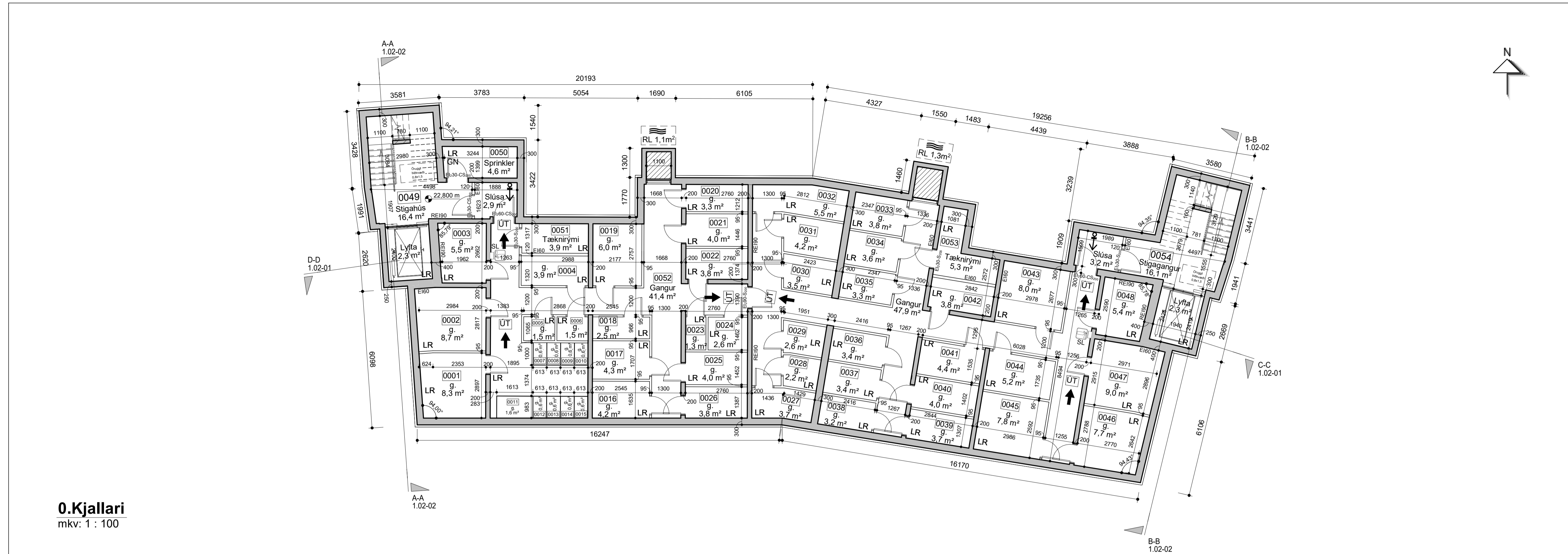

0.Kjallari
mkv: 1 : 100



1.hæð hús 6
mkv: 1 : 100

Öf áhrif og affrit teiknings, að hluta eða heild, er það samþykkt höfundar, skv. ákvarðun höfundalaga.

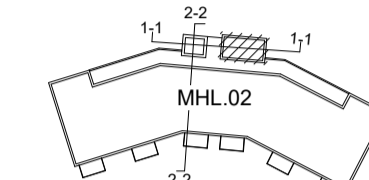
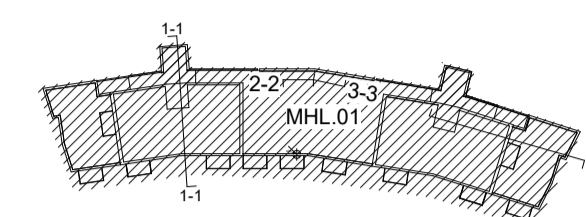

- Brunalokanir
- Brunaslanga
- Gat í gólf
- Gat í lofti
- Niðurfallsrör
- Gólfniðurfali
- Loftþræsting
- Handslökkvitaki
- Reykskyrjar
- Reyklosun
- Lagnagrind vatnsúðarakerfi
- Stjórtaflla brunv. kerfis
- Tvíburatengi
- ÚT merking
- Björgunnarop



T.ark
ARKITEKTAR
HÁTUÐI 2b - 105 REYKJAVÍK
SÍMI: 540 5700
tark@tark.is - www.tark.is

VERKHEITI
Hringhamar 6-8, 221 Hafnarfirði
Fjölbýlishús
Aðaluppdrættir

TEKNIING
MHL 01 Grunnmynd hús nr 6, 2. og 3.hæð

MÁL: 1 : 100 / A1
DAGS: 01.06.2023
HANNAD: ÁÁ
TEKNAÐ: ÓF/ KAS
YFIRARÍÐ: ISC
VERKNÖMUR: 751-781
FL: 04
TEKNINGANÖMUR: 1.01-03
ÖTG



2.hæð hús nr. 6
mkv: 1 : 100

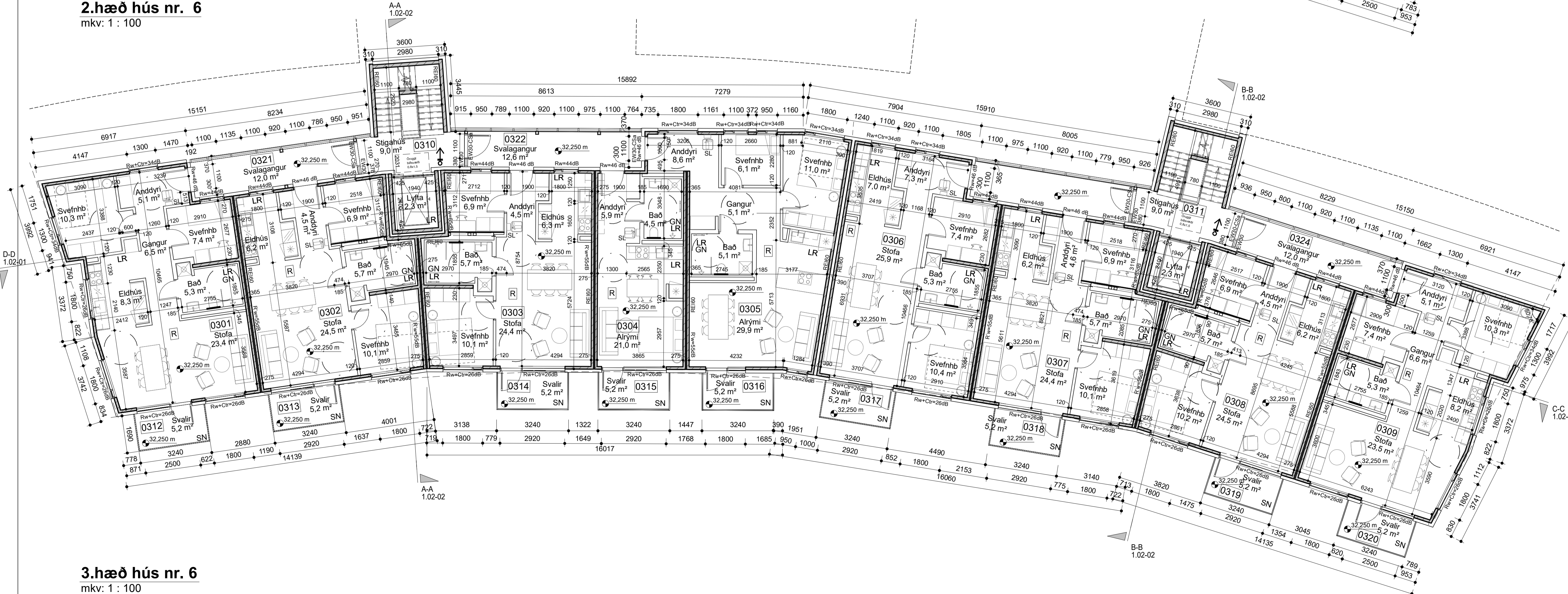

3.hæð hús nr. 6
mkv: 1 : 100

Öf afrit og afrit tekið, að hluta eða heild, er það samþykki höfundar, skv. ákvarðunum löfundaála.

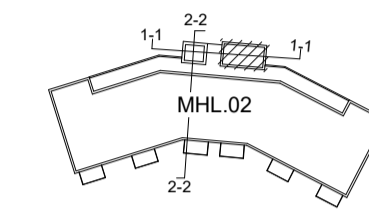
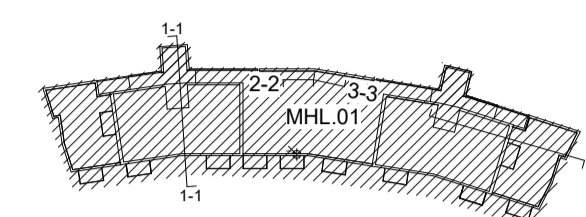

- 2.2x2.2 El:60Csm Brunalokanir
- 30m Brunaslanga
- GP Gat i gólf
- SL Gat i lofti
- NF Niðurfallsör
- GN Gólfniðurfall
- LR Lofttræsting
- SL Handslökkvitæki
- R Reykskyngjar
- Reyklosun
- Lagnagrind vatnsúðarakerfi
- Stjórntaflla brunv. kerfis
- Tvíviratengi
- UT UT merking
- B.O. Björgunnarop

BREYTINGAR

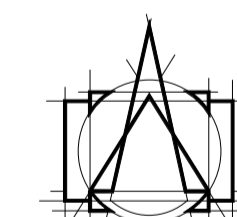

T.ark
ARKITEKTAR
HÁTÚNI 2b - 105 REYKJAVÍK
Sími: 540 5700
tor@tark.is - www.tark.is

VERKHETI
Hringhamar 6-8, 221 Hafnarfirði

Fjölbýlishús
Aðaluppdrættir

TEKNIING

MHL 01 Grunnmynd húsnr 6, 4. og 5.hæð

MÁL: 1 : 100 / A1
DAGS: 01.06.2023
HANNAD: ÁÁ
TEKNAÐ: ÓF/ KAS

YFIRFARID: ISC
VERKNÖMUR: FL TEKNINGANÖMUR ÖTG

751-781 04 1.01-04

SAMP: Ásgeir Ásgeirsson ARKIBAKI MAA SAMARK KL:060161-6429

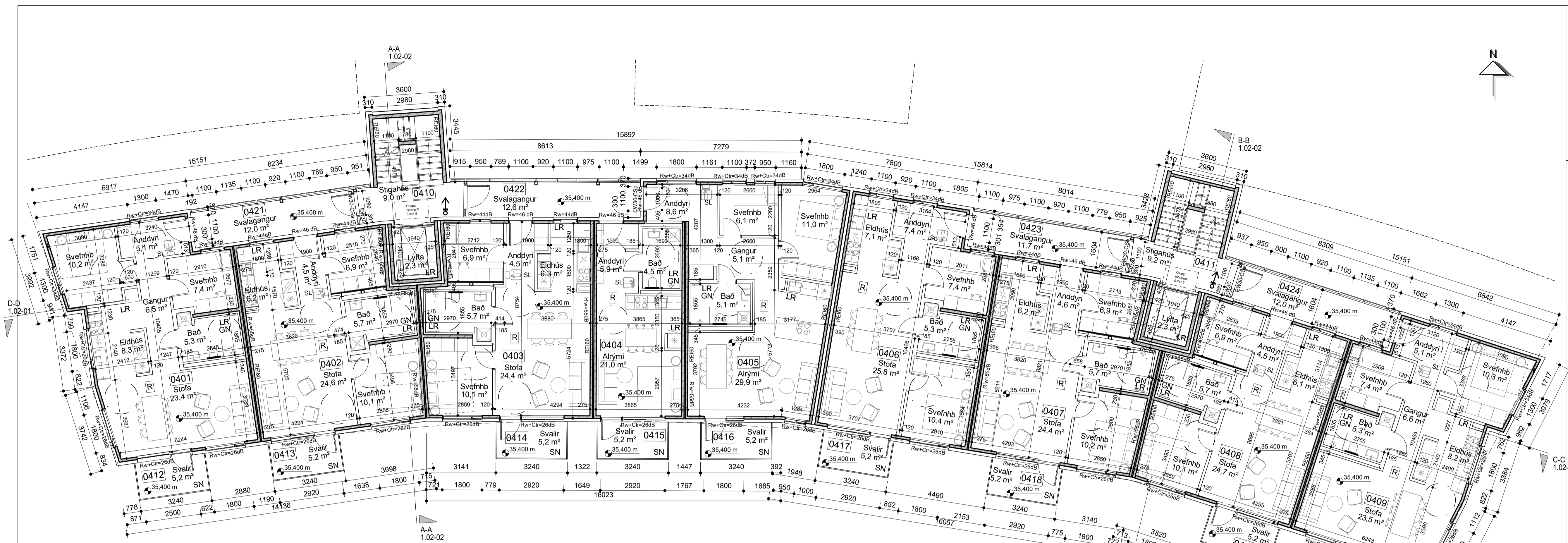

4.hæð húsnr. 6
mkv: 1 : 100

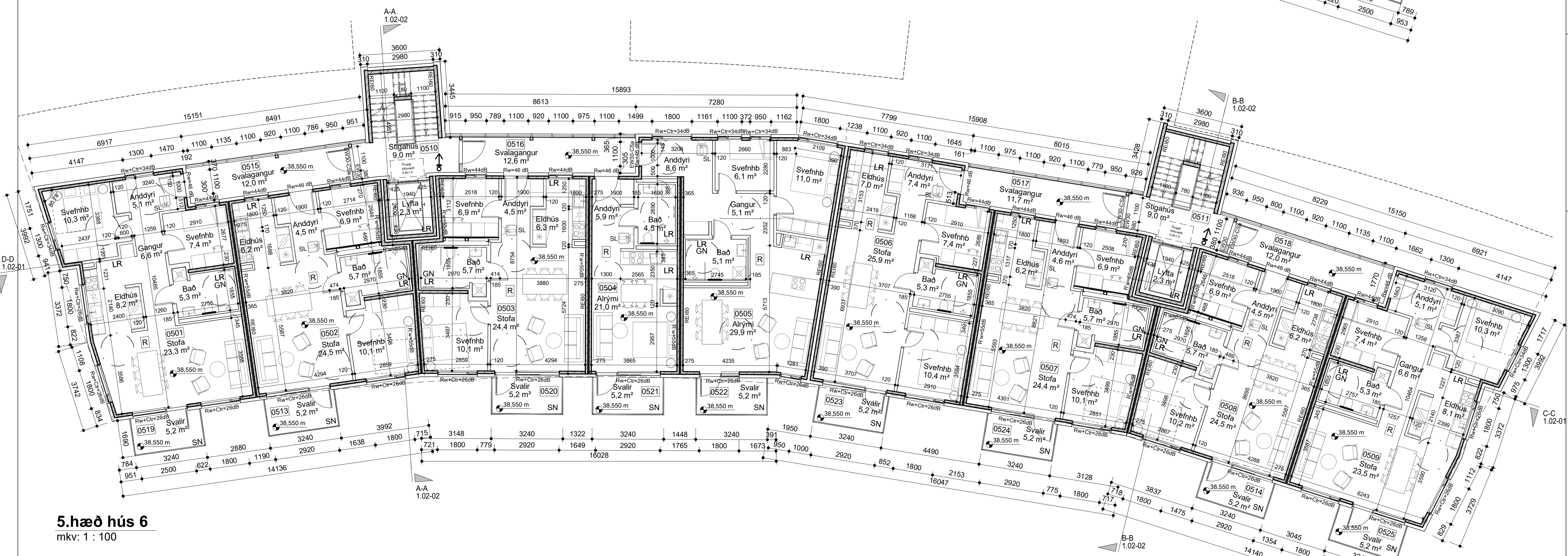

5.hæð húsnr. 6
mkv: 1 : 100

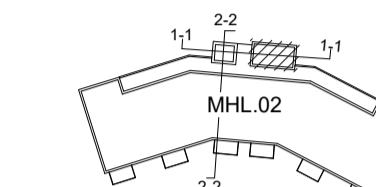
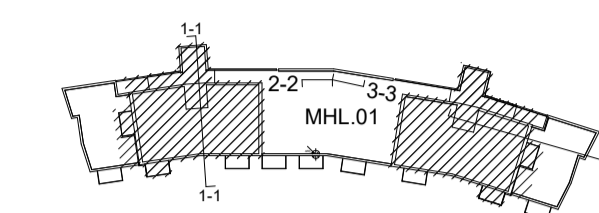

- Brunalokanir
- Brunaslanga
- Gat í gölf
- Gat í lofti
- Niðurfallsrör
- Gólfniðurfall
- Loftþræsting
- Handslökkvitteki
- Reykskyrjar
- Reyklosun
- Lagnagrind vatnsúðarakerfi
- Stórtaflla brunv. kerfis
- Tvíburatengi
- ÚT merking
- Björgunnarop

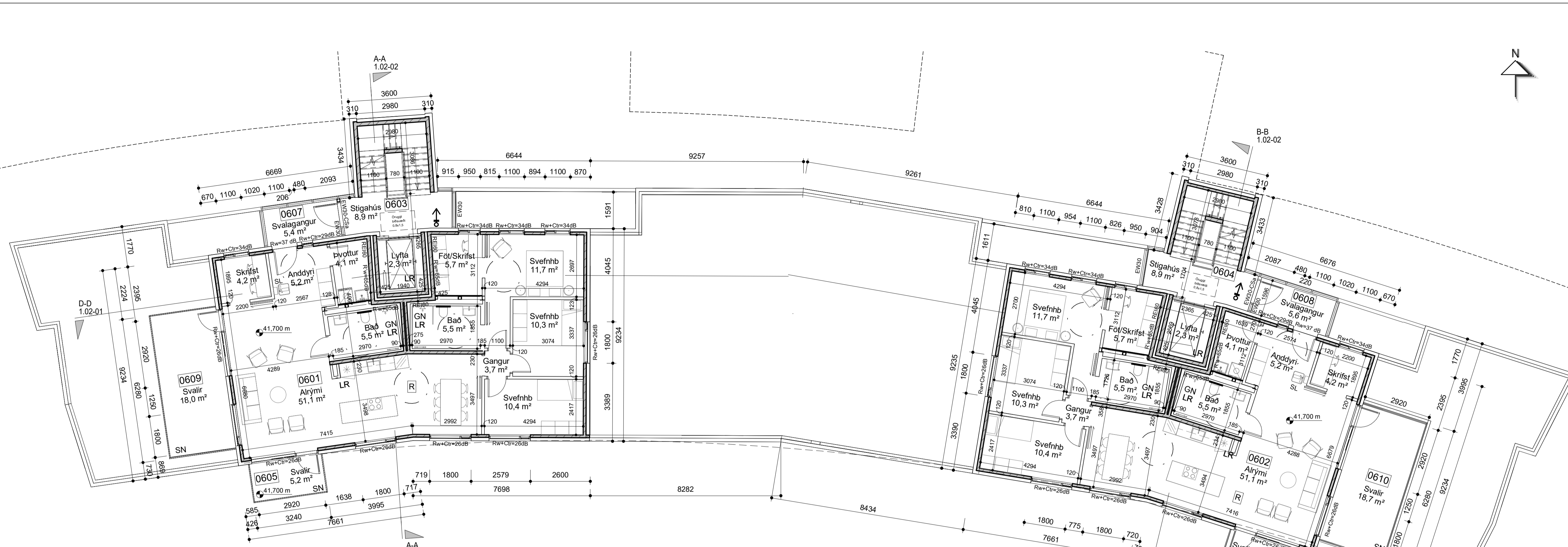

6.hæð hús nr. 6
mkv: 1 : 100

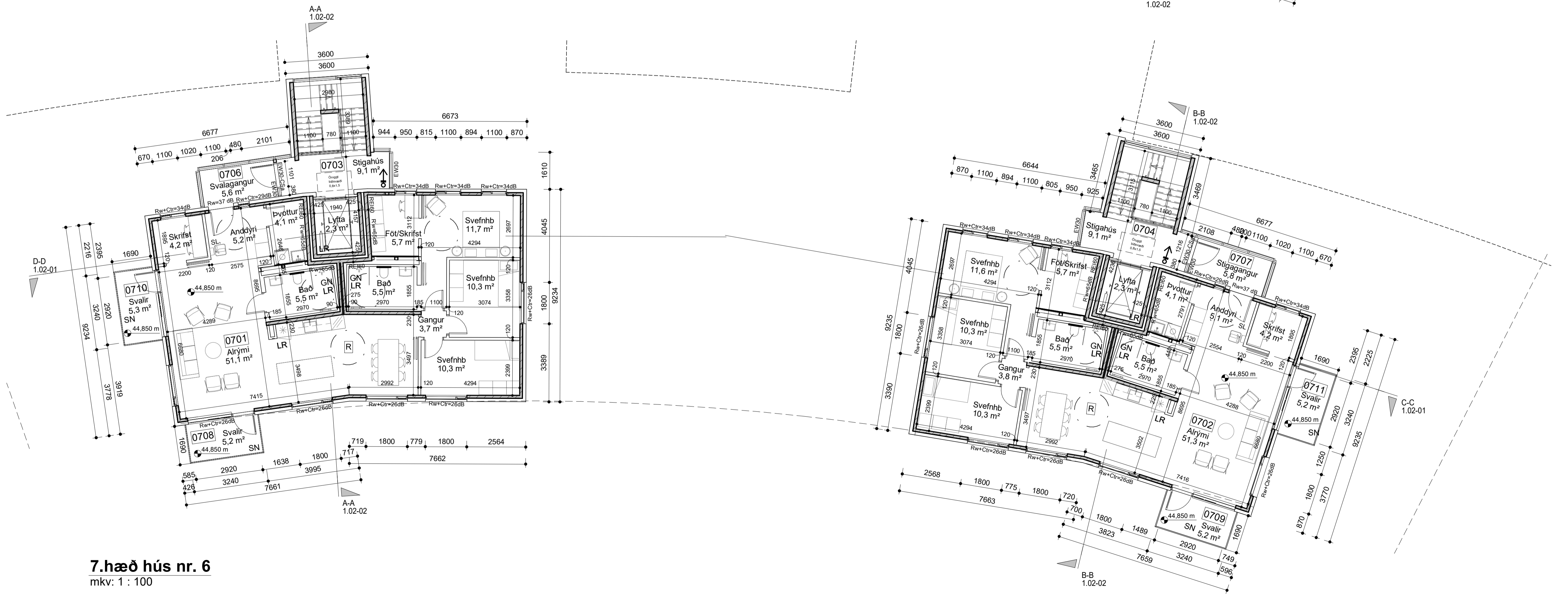

7.hæð hús nr. 6
mkv: 1 : 100

BREYTINGAR

T.ark
ARKITEKTAR
HÁTUÐI 2b - 105 REYKJAVÍK
SÍMI: 540 5700
tark@tark.is - www.tark.is

VERKHEITI
Hringhamar 6-8, 221 Hafnarfirði
Fjölbýlishús
Aðaluppdrættir

TEKNIING
MHL 01 Grunnmynd hús nr 6, 6. og 7.hæð

MÁL:
1 : 100 / A1

DAGS:
01.06.2023

HANNAÐ:
ÁÁ

TEKNAÐ:
ÓF/ KAS

YFIRFARID:
ISC

VERKNÖMUR
751-781

FL
04

TEKNIINGANÖMUR
1.01-05

ÓTG

SAMP. Ásgeir Ásgeirsson ARKIBAK MAA SAMARK KL.060161-5429

Öf árituð og afrit tekið, að hluta eða heild, er háð samþykki forfunda, skv. ákvaðnum tofurdagla.

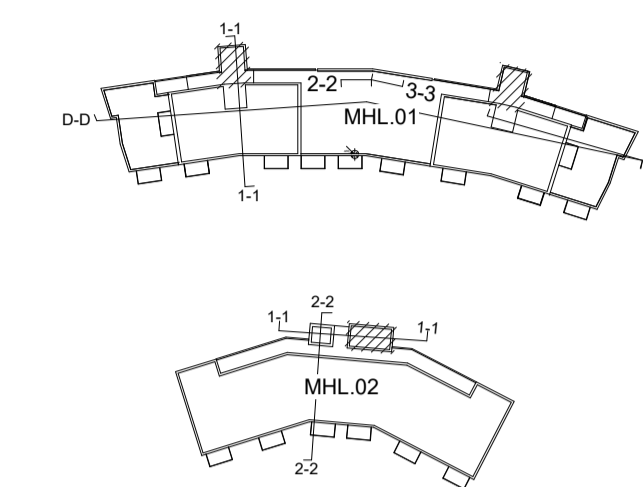

Snið C
 mkv: 1 : 100

Snið D
 mkv: 1 : 100

BREYTINGAR

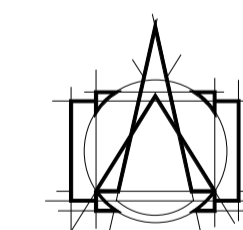

T.ark
 ARKITEKTAR
 HÁTÚNI 2b - 105 REYKJAVÍK
 Sími: 540 5700
 tor@tark.is - www.tark.is

VERKHEITI
 Hringhamar 6-8, 221 Hafnarfirði
 Fjölbýlishús
 Aðaluppdrættir

TEIKNING
 MHL 01 Sneiðingar hús nr. 6

MÁL: 1 : 100 / A1
 HANNAÐ: ÁÁ
 YFIRFARID: ISC
 DAGS: 01.06.2023
 TEIKNAD: ÓF/ KAS

VERKNÖMUR FL TEIKNINGANÖMUR ÖTG
 751-781 04 1.02-01

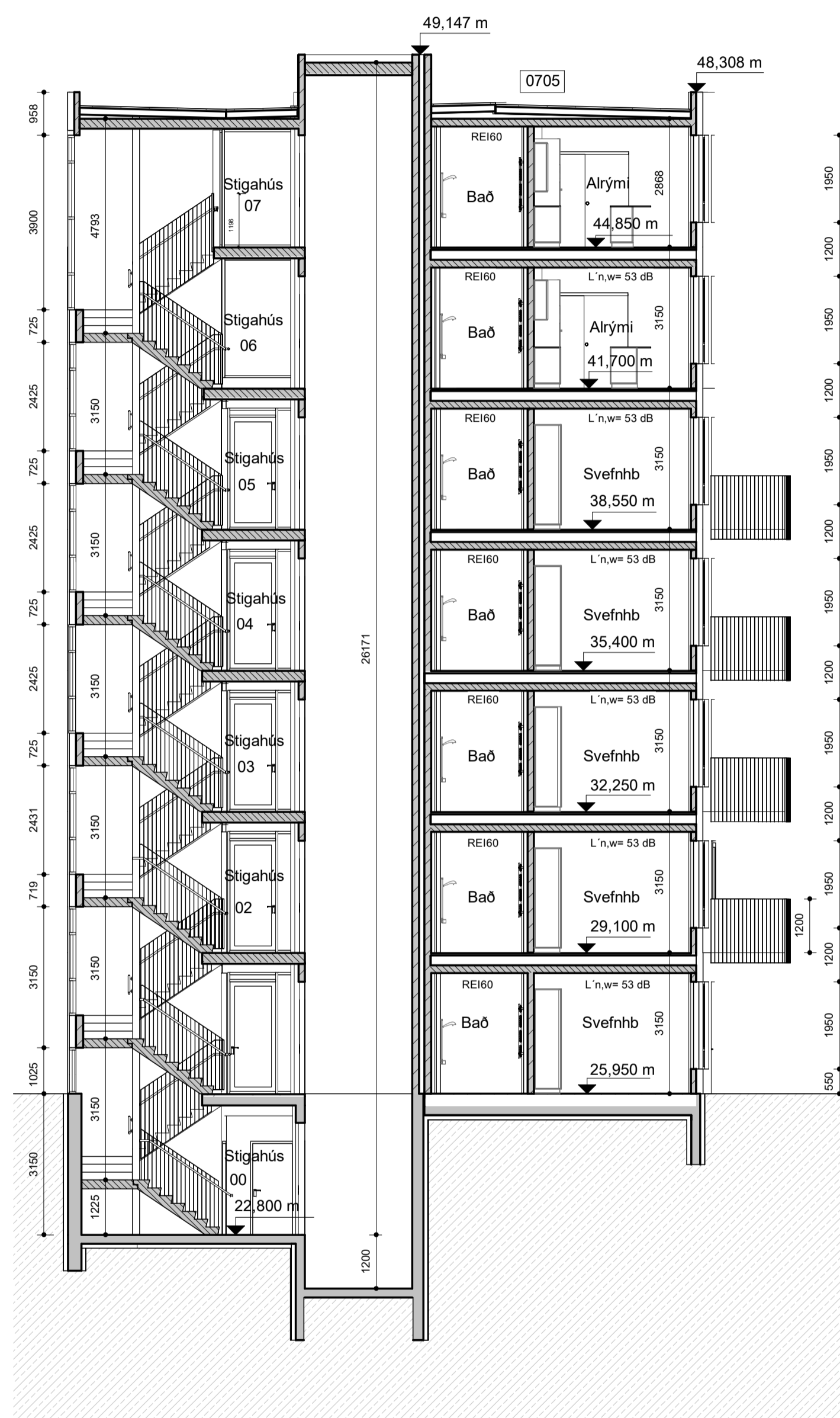
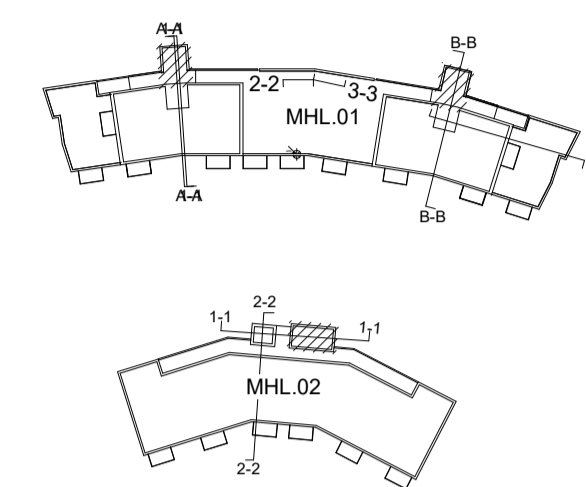

Snið A
 mkv: 1 : 100

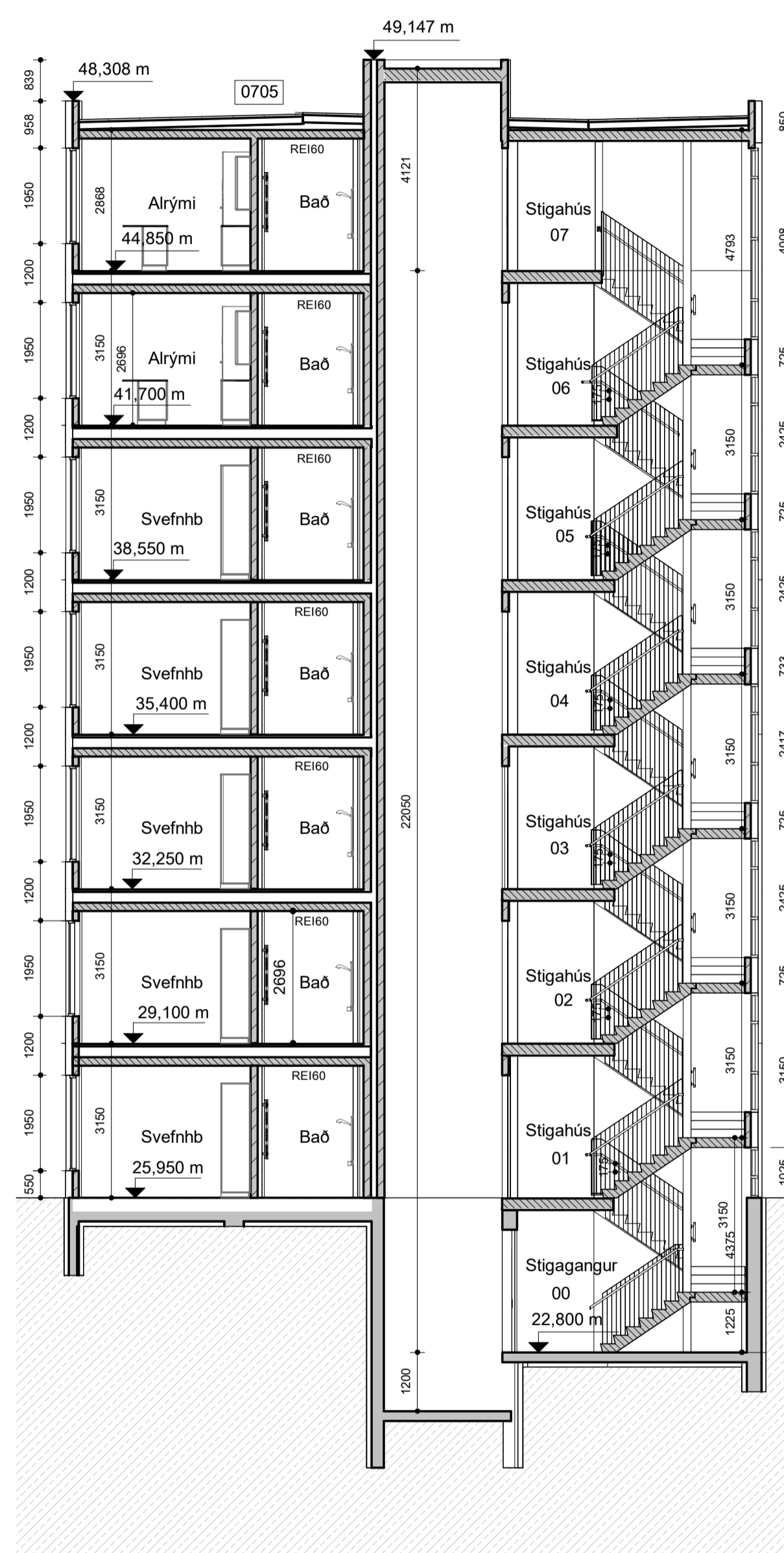

Snið B
 mkv: 1 : 100

BREYTINGAR

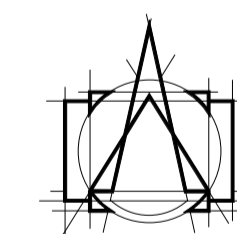

T.ark
 ARKITEKTAR
 HÁTÚNI 2b - 105 REYKJAVÍK
 Sími: 540 5700
 tor@tark.is - www.tark.is

VERKHEITI
 Hringhamar 6-8, 221 Hafnarfirði
 Fjölbýlishús
 Aðaluppdrættir

TEIKNING
MHL 01 Sneiðingar hús nr 6

MÁL: 1 : 100 / A1
 HANNAÐ: ÁÁ
 YFIRFARID: ISC

DAGS: 01.06.2023
 TEIKNAD: ÖF/ KAS

VERKNÖMUR: 751-781
 FL: 04
 TEIKNINGANÖMUR: 1.02-02
 ÖTG

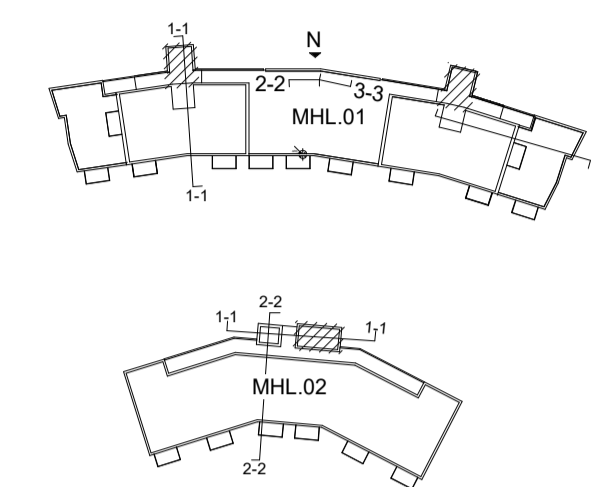

Norður hús nr 6
 mkv: 1 : 100

BREYTINGAR

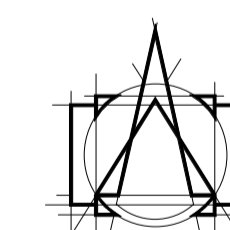

T.ark
 ARKITEKTAR
 HÁTÚNI 2b - 105 REYKJAVÍK
 Sími: 540 5700
 tark@tark.is - www.tark.is

VERKHEITI
 Hringhamar 6-8, 221 Hafnarfirði
 Fjölbýlishús
 Aðaluppdrættir

TEIKNING
 MHL 01 Útlit hús nr 6, norður

MÁL: 1 : 100 / A1
 DAGS: 01.06.2023
 HANNAÐ: ÁÁ
 TEIKNAD: ÓF/ KAS
 YFIRFARID: ISC

VERKNÖMUR	FL	TEIKNINGANÖMUR	ÓTG
751-781	04	1.03-01	

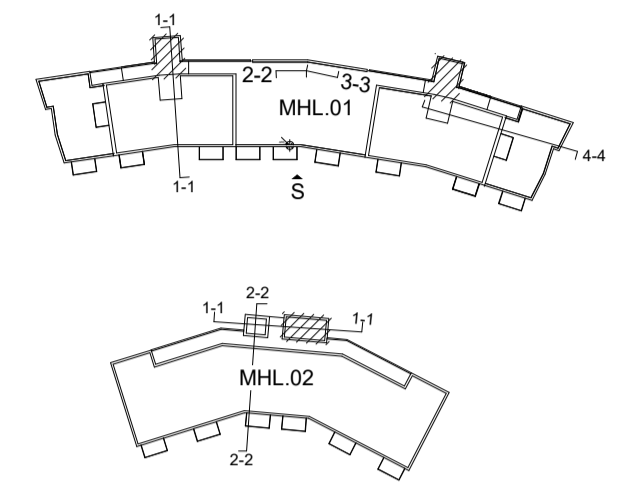

Suður hús nr 6
 mkv: 1 : 100

BREYTINGAR

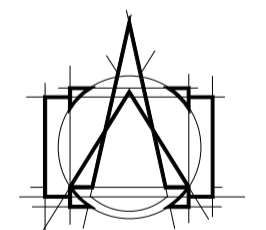

T.ark
 ARKITEKTAR
 HÁTÚNI 2b - 105 REYKJAVÍK
 Sími: 540 5700
 tark@tark.is - www.tark.is

VERKHEITI

TEIKNING
MHL 01 Útlit hús nr 6, suður

MÁL: 1 : 100 / A1
 DAGS: 01.06.2023
 HANNAÐ: ÁÁ
 TEIKNAD: ÖF/ KAS
 YFIRFARID: ISC

VERKNÖMUR	FL	TEIKNINGANÖMUR	ÓTG
751-781	04	1.03-02	

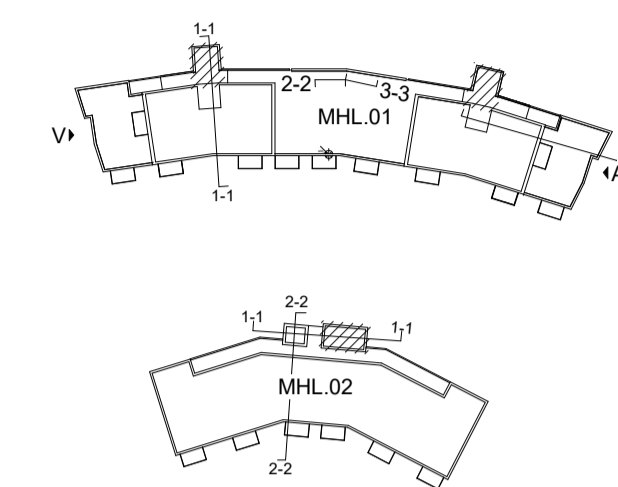

Austur hús nr 6
 mkv: 1 : 100

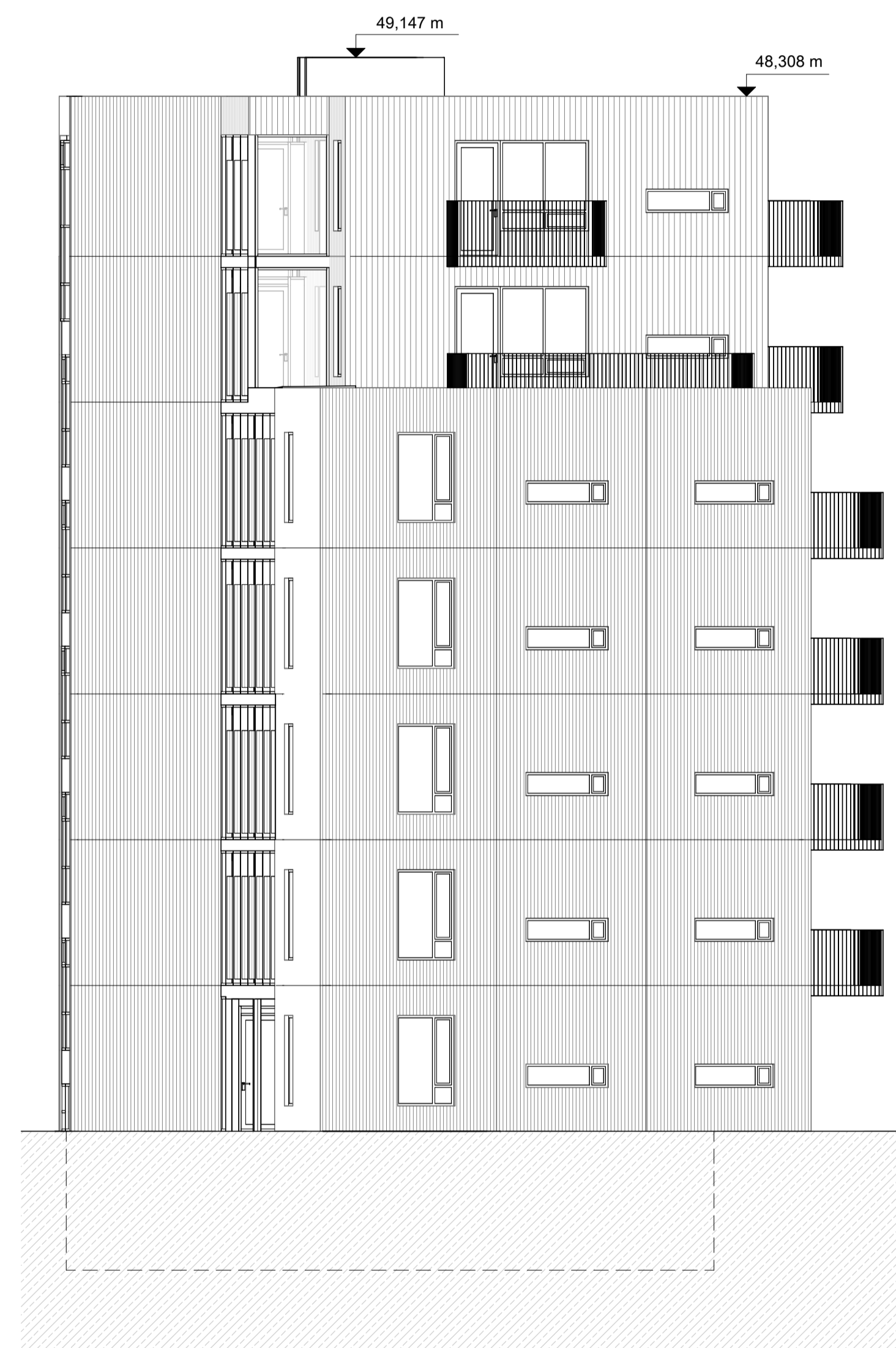

Vestur hús nr 6
 mkv: 1 : 100

BREYTINGAR

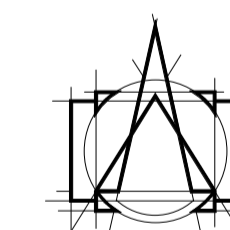

T.ark
 ARKITEKTAR
 HÁTÚNI 2b - 105 REYKJAVÍK
 Sími: 540 5700
 tark@tark.is - www.tark.is

VERKHEITI
 Hringhamar 6-8, 221 Hafnarfirði
 Fjölbýlishús
 Aðaluppdrættir

TEIKNING
MHL 01 Útlit hús nr 6, austur og vestur

MÁL: 1 : 100 / A1
 HANNAÐ: ÁÁ
 YFIRFARID: ISC

DAGS: 01.06.2023
 TEIKNAD: ÖF/ KAS

VERKNÖMUR FL TEIKNINGANÖMUR ÖTG
 751-781 04 **1.03-03**

Lýsing:

Aðkomuleiðir slökkviliðs eru lágmark þriggja metra breiðar með hámarkshalla undir 1:20 og lágmarks beygjuradius 17 metra. Björgunarsvæði eru 6 metra breið. Í inngarði er aðkomuleið og björgunarsvæði á þjöppuðum malarpúða og ofan á hann kemur burðarhæfur frágangur, t.d. 8 cm grassteinn, Ecoraster E50 plastsellur eða sambærilegt sem þolir lágmark 85 tonn/m² til að þola þunga frá stöðormum körfubíls (17,5 tonn) án stálplatta undir.

Aðkomuleiðir og björgunarsvæði eru ekki yfir kjallararymum.

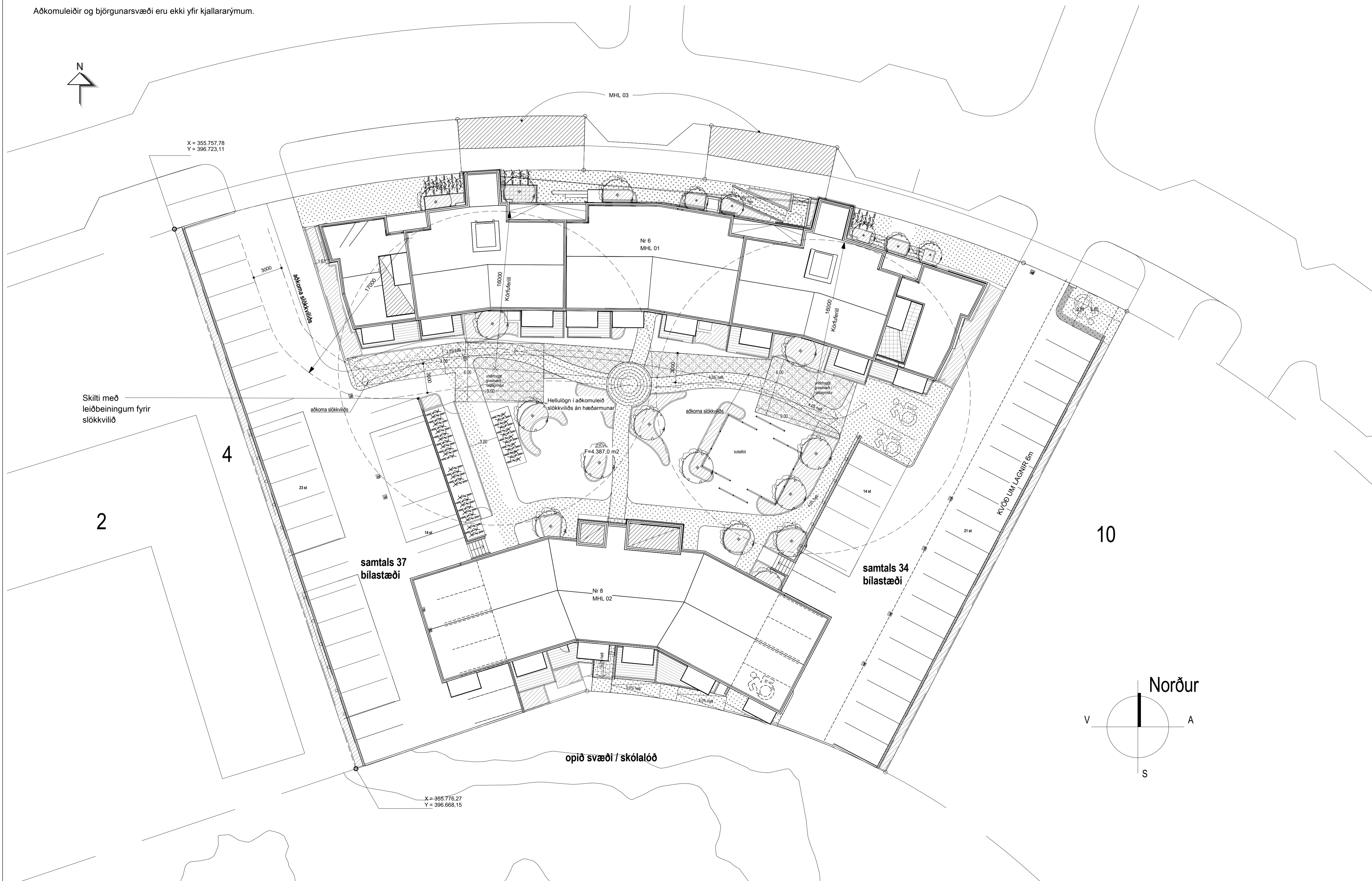

BREYTINGAR

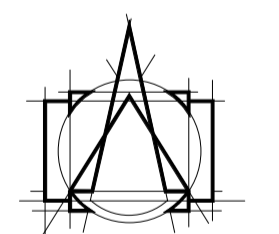

T.ark
ARKITEKTAR
HÁTÚNI 2b - 105 REYKJAVÍK
SÍMI: 540 5700
tark@tark.is - www.tark.is

VERKHEITI
Hringhamar 6-8, 221 Hafnarfirði
Fjölbýlishús
Aðaluppdrættir

TEIKNING
MHL 01, 02 og 03 yfirlit fyrir
slökkvilið

MÁL: 1 : 200 / A1
HANNAD: ÁÁ
YFIRFARID: ISC

DAGS: 19.10.2023
TEIKNAD: ÓF

VERKNÖMUR: 751-781
FL: 04
TEIKNINGANÖMUR: 1.04-01
ÓTG

MHL. 01, bls. 1

Table with columns for Landingsnúmer, Skráningartafla, and various data points for building permits.

MHL. 01, bls. 2

Table with columns for Landingsnúmer, Skráningartafla, and various data points for building permits.

MHL. 03

Table with columns for Landingsnúmer, Skráningartafla, and various data points for building permits.



BREYTINGAR

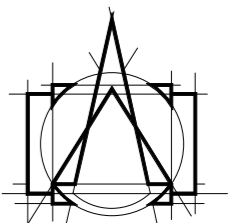

T.ark ARKITEKTAR
HÁTÚNI 2b - 105 REYKJAVÍK
Sími: 540 5700
tark@tark.is - www.tark.is

VERKHEITI
Hringhamar 6-8, 221 Hafnarfirði
Fjölþýlishús
Aðaluppdrættir

TEIKNING
MHL 01 og 03 Skráningartafla

MÁL: / A2
DAGS: 01.06.2023
MHL.:
HÁNNAD: ÁÁ
TEIKNAD: SA
YFIRFARID: ISC
VERKNÓMUR FL TEIKNINGANÓMUR ÚTG

751-781 04 1.04-03